

Genuine Accessories



Vehicle Model: **G70**

Model Year 2019-
 Part No. G9F13 AU000 (RWD)
G9F13 AU100 (AWD)
 Language English
 Rev. Date 4/16/2018

Accessory: **All-Season Fitted Liners**

Difficulty: (A)

Note: Difficulty stated above reflects the minimum level of expertise required to install the accessory:
 (A) Customer
 (B) Dealer Technician
 (C) Master Technician or Specialist

Instructional Symbols / Definitions

	Denotes warnings that may lead to serious physical injury or vehicle damage		Denotes quality processes to be checked prior to moving to the next step	Denotes personal protective equipment (PPEs) that may be required for a step. Examples of safety equipment icons noted below:	
	Denotes cautions to be taken to avoid physical injury or electronic component damage		Denotes specific tools that are necessary to complete a step		
	Denotes cautions to be taken to avoid vehicle and component damage	N O T E	Denotes important information to be reviewed during the step		

Basic Required Tools

None

Part Weight (Gross)

3.747 lbs
1.700 kg

FMVSS 110 Compliance Information

All dealers must determine if the weight they have added in the form of all options or accessories, when added to the weight of all Port/Dealer Installed options or accessories, exceeds the lesser of 1.5% of GVWR or 100 lbs. If the additional weight does exceed the lesser of the indicated thresholds, a "Load Carrying Capacity Reduced" label must be installed. A black, fine-point, indelible marker must be used to write by hand onto the label, the reduced carrying capacity in kilograms or pounds, which is the total weight of all added options and accessories.
Load Label Part Number: NP070 - 09003



Warning! Ensure that each All-Season Fitted Liner is securely attached to the vehicle's floor mat anchor(s) before driving the vehicle. This helps keep the All-Season Fitted Liner from sliding forward. If the All-Season Fitted Liner slips and interferes with the movement of the pedals during driving, it may cause an accident.

Do not put an additional Floor Mat on top of the anchored All-Season Fitted Liner, otherwise the additional mat may slide forward and interfere with the movement of the pedals.

Notes to the installer:

- 1) Dealer must clearly advise customer of installation method.
- 2) Before installing, verify and identify all parts.
- 3) Remove vinyl factory covering from carpeted areas before installation, if applicable.
- 4) Sliding driver and passenger seats to furthest rearward position provides better access to install front All-Season Fitted Liners properly.
- 5) When removing mats or liners, be sure to hold grommet and mat/liner at the same time, then pull forward.

Genuine Accessories

Kit Overview

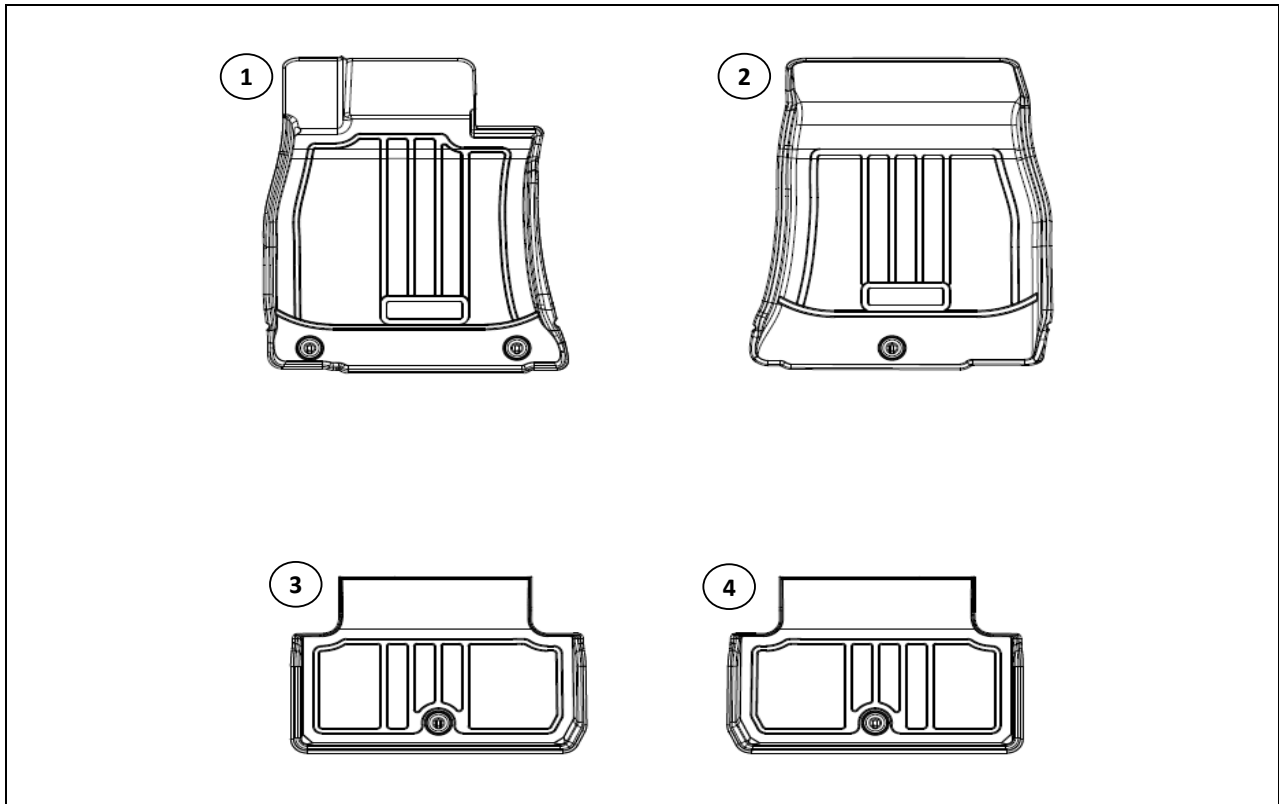



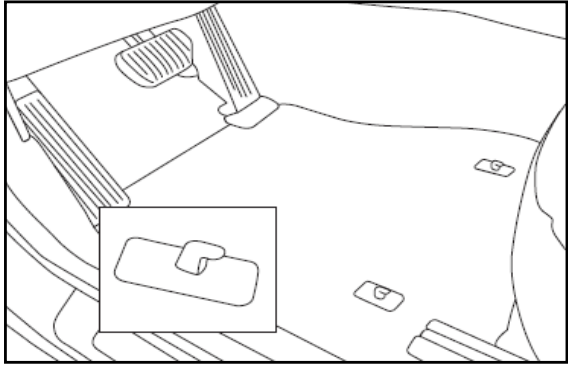

No.	Qty	Description
1	1	Left (Driver) Front All-Season Fitted Liner
2	1	Right (Passenger) Front All-Season Fitted Liner
3	1	Left Rear All-Season Fitted Liner
4	1	Right Rear All-Season Fitted Liner

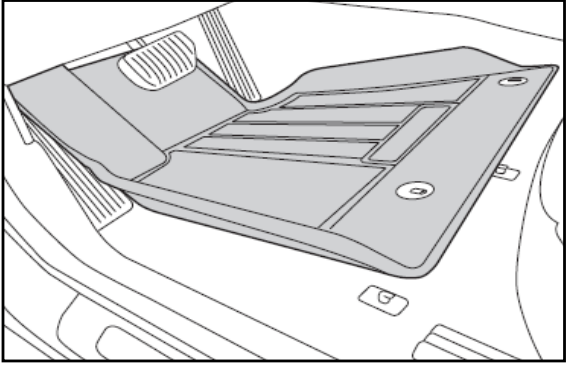
Genuine Accessories

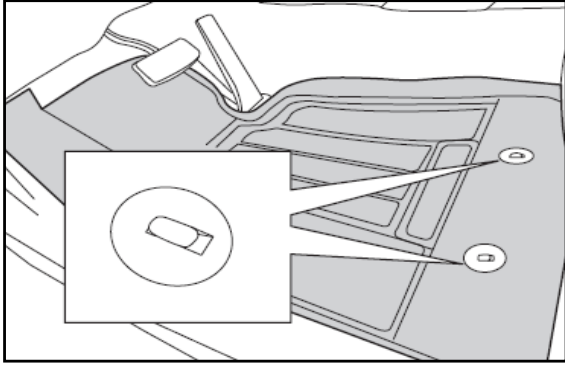
1		
		
N O T E	<p>A. Before installation, remove all floor mats from the front and rear of the vehicle.</p> <p>B. Starting with the left front driver's side floor area, make sure it is clean and that the retention hooks are properly attached to the floor carpet.</p>	

2		
		
N O T E	<p>A. Position the Left (Driver) Front All-Season Fitted Liner by inserting the front portion under the brake pedal (and clutch pedal for Manual Transmission models) area and allow the liner to gently fall into place.</p>	

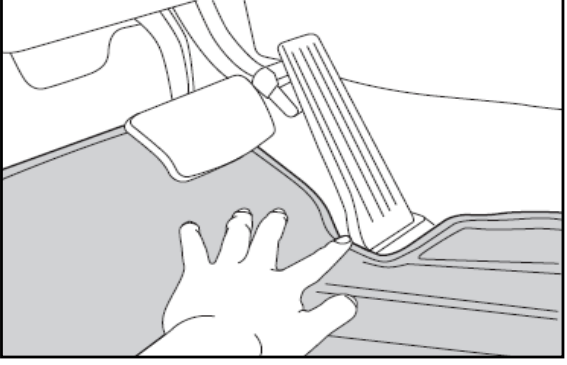

3		
		
N O T E	<p>A. Align the plastic grommets with the retention hooks protruding from the vehicle floor. If necessary, rotate the grommets in the liner to align it with the retention hooks.</p> <p>B. Firmly apply pressure onto the plastic grommets to fully engage them with the retention hooks.</p> <p>TIP: Slightly lifting the front portion of the Liner will ease engagement of the grommets with the retention hooks.</p>	
	<p>Ensure the Floor Liner's plastic grommets have fully engaged with the floor retention hooks.</p>	

4		
		
N O T E	<p>A. Press the driver's side All-Season Fitted Liner down against the floor, making sure it does not interfere with any of the pedals.</p>	
	<p>CAUTION! Any interferes with the movement of the pedals during driving, may cause an accident.</p>	

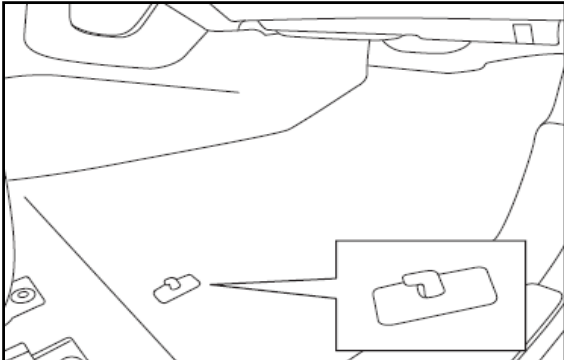
Genuine Accessories

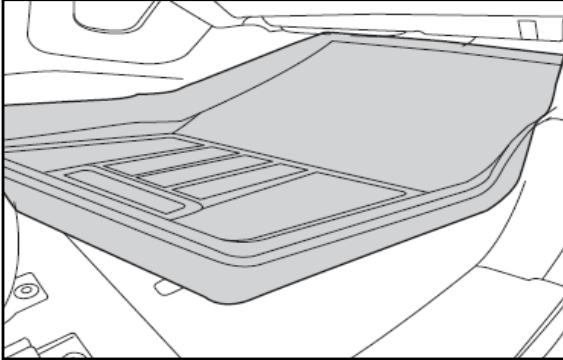
5		
		
N O T E	<p>A. At the right front passenger's side floor area, make sure it is clean and that the retention hook is properly attached to the floor carpet.</p>	

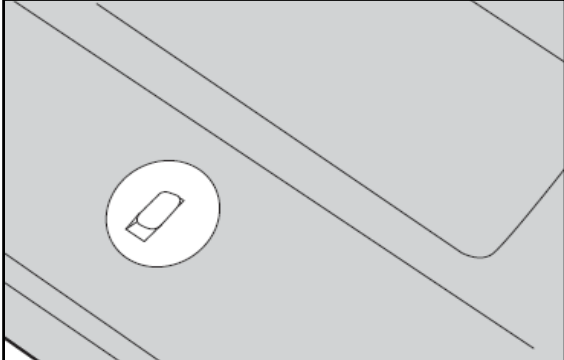
6		
		
N O T E	<p>A. Position the Right (Passenger) Front All-Season Fitted Liner by inserting the front portion under the lower dash area and allow the liner to gently fall into place.</p>	

7		
		
N O T E	<p>A. Align the plastic grommet with the retention hook protruding from the vehicle floor. If necessary, rotate the grommet in the liner to align it with the retention hook. B. Firmly apply pressure onto the plastic grommet to fully engage it with the retention hook. TIP: Slightly lifting the front portion of the Liner will ease engagement of the grommet with the retention hook.</p>	
	<p>Ensure the Floor Liner's plastic grommet has fully engaged with the floor retention hook.</p>	

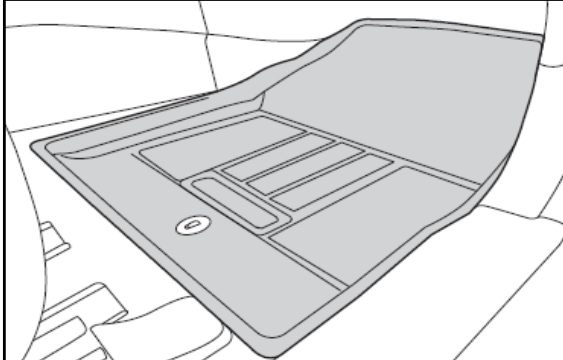
8		
		
N O T E	<p>A. Press down on the Right (Passenger) Front All-Season Fitted Liner making sure that the edges are fully pressed down against the floor.</p>	

Genuine Accessories

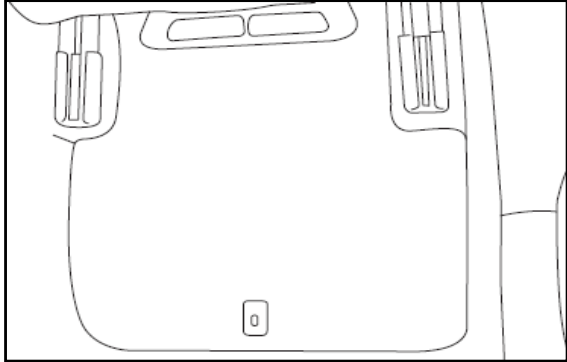
9		
		
N O T E	<p>A. At the left rear passenger's side floor area, make sure it is clean and that the retention hook is properly attached to the floor carpet.</p>	

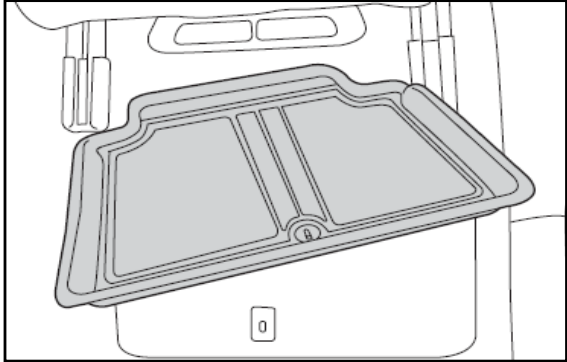
10		
		
N O T E	<p>A. Position the Left Rear All-Season Fitted Liner by inserting the front portion between the front seat rails and allow the liner to gently fall into place.</p>	

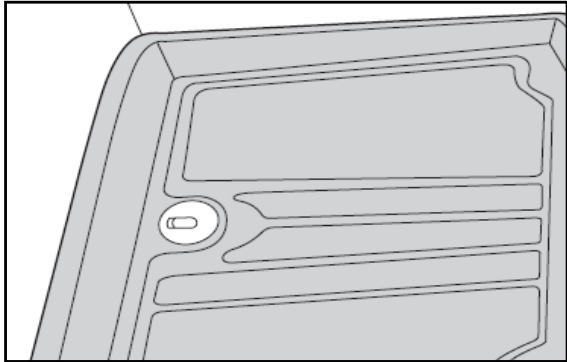

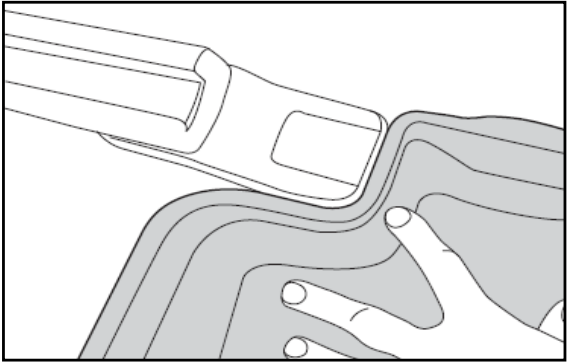
11		
		
N O T E	<p>A. Align the plastic grommet with the retention hook protruding from the vehicle floor. If necessary, rotate the grommet in the liner to align it with the retention hook. B. Firmly apply pressure onto the plastic grommet to fully engage it with the retention hook. TIP: Slightly lifting the front portion of the Liner will ease engagement of the grommet with the retention hook.</p>	
	<p>Ensure the Floor Liner's plastic grommet has fully engaged with the floor retention hook.</p>	

12		
		
N O T E	<p>A. Press down on the Left Rear All-Season Fitted Liner making sure that the liner is flush against the front seat rail covers, there is no interference, and that the edges are fully pressed down against the floor. B. Repeat steps 9-12 for the Right Rear All-Season Fitted Liner. C. Installation is complete.</p>	

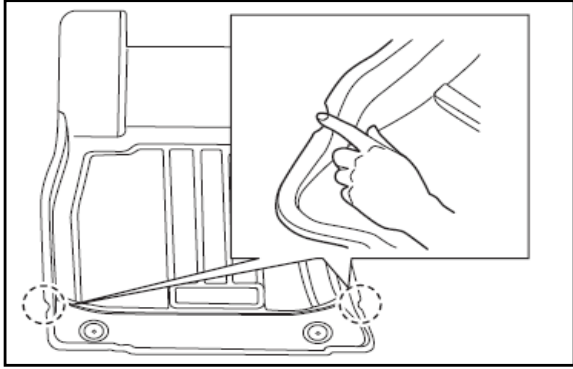
Genuine Accessories

13		
All-Season Fitted Liners Removal Procedure:		
		
N O T E	<p>A. To prevent any damage when uninstalling the All-Season Fitted Liners, utilize the 2 Finger Access point to remove the Left (Driver) Front and Right (Passenger) Front All-Season Fitted Liners.</p>	

Visual Check

	Item to be Checked
	Make sure the accelerator and brake pedals are not interfering with floor liner.
	Make sure each floor liner plastic grommet is securely fastened to the vehicle floor with each retention hook.

Result	
No interference with accelerator and brake pedals.	
Each liner properly attached to each retention hook.	

Genuine Accessories

Care & Cleaning

Cleaning Instructions for:

G70

All-Season Fitted Liners

Each All-Season Fitted Liner can easily be cleaned using a vacuum, soft cloth, or soft brush.

To remove excess dirt, use water with a mild detergent to clean the liner. Do not use bleach or alcohol to clean the liner or the liner may become damaged or discolored.

Dry the liner with a soft cloth or place the liner in a well ventilated area to dry before reinstalling. If the liner is installed before it is completely dry, it could become moldy or emit an abnormal smell.

Do not place the liner on the ground where it is in direct contact with the sun, or the liner could deform from high temperatures.

Do not use a washing machine or automatic mat cleaner to clean the liner. The liner could become damaged and/or deformed.